

Overview and Quick Start

Introduction to phone exterior

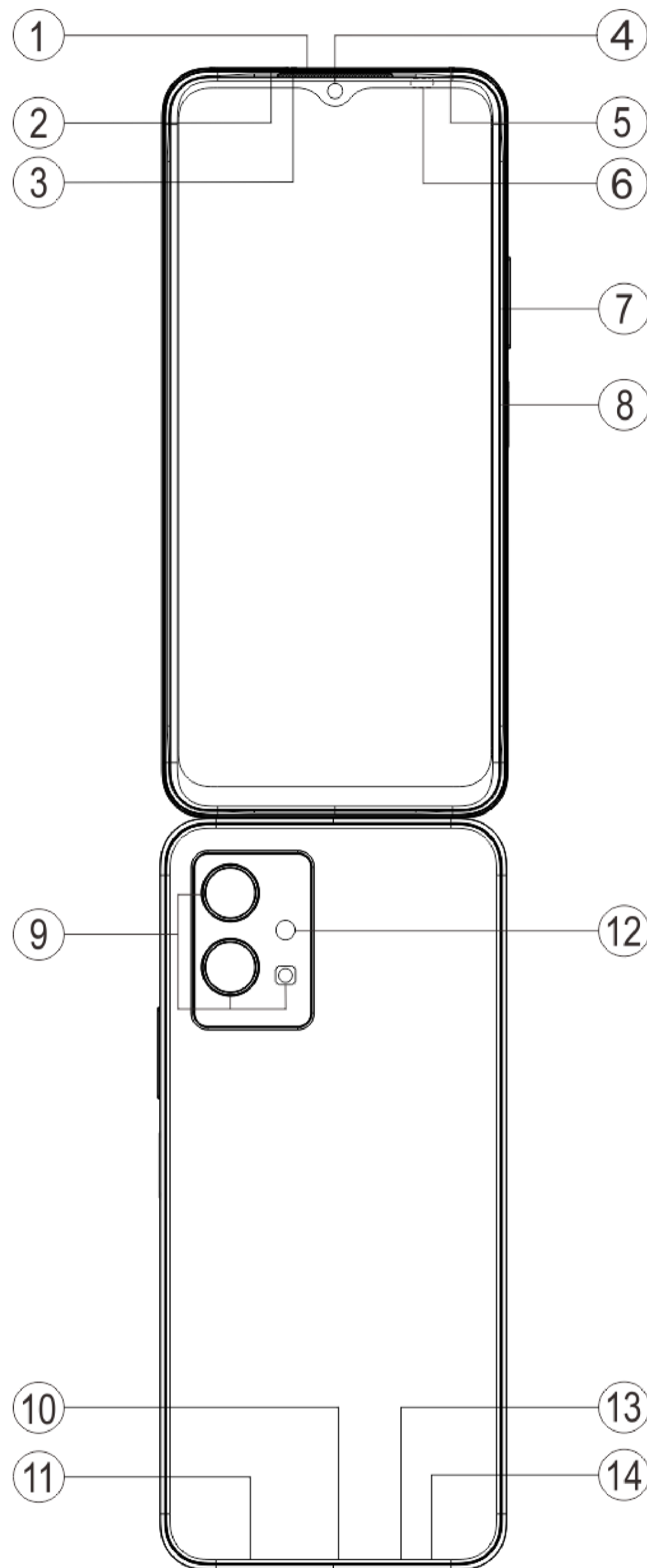

Note

There may be some differences depending on your phone model. The pictures used in these instructions are for reference only. Please refer to the actual product in use.

Introduction to keys and widgets

1. **⑥ Ambient light sensor & Proximity sensor:** Automatically detect the intensity of the ambient light, and adjust the brightness of the screen based on the ambient light.

When making phone calls, this sensor automatically detects the distance between you and your phone. If you're too close to your phone, it will switch off your screen to avoid unintentional triggering of certain functions. The sensor is inactive in headset and handsfree mode. It is normal for the light at the top of the screen to flash briefly when dialing or calling. This indicates the screen's infrared is working.



2. ⑦**Volume button**: You can adjust the volume using the volume button.
3. ④**Front camera**/⑨**Rear camera**: You can take photos and record videos.
4. ①**Receiver**: You can hear the caller through the receiver when on the phone.
5. ⑧**Power button & Fingerprint sensor** : Press and hold the power button in power off mode to turn on the mobile phone. Long press the button in boot mode to turn off the phone or reboot the phone.

The button has the fingerprint recognition function, which can be used to unlock the phone instead of using the password.

Note

When the phone can not be used normally, simultaneously press the [**Power button**] and [**Volume button -**] for more than 10 seconds to force the device to restart .

6. ②**SIM card tray**: Install/Remove the cards.
7. ③**SIM card eject hole**: Insert the ejector tool into the hole and press it until the card tray ejects, and then remove the card tray.
8. ⑬**Main microphone**/⑤**Secondary microphone**: Transfer sound when you make calls.
9. ⑫**Flash**: Flashlight source.
10. ⑪**Speaker**: Playing sound.
11. ⑩**USB port**: You can connect your phone to other devices such as a charger or computer using a data cable.
12. ⑭**Headset port**: You can connect headphones to your phone using the headphone jack.

Installation and Preparation

Procedure for installing SIM

 **Note:** You may have a single or dual SIM phone based on the needs of your region or carrier, but the differences between the two versions are not fully covered in the instructions. The pictures used in these instructions are for reference only and may differ from your phone.

This phone supports hot swapping of Nano card (SIM1/SIM2). When the phone is on, it can automatically recognize a Nano card (SIM1/SIM2) when you plug the card in.

This phone supports Nano card (SIM1/SIM2).

1. Insert the ejector tool into the hole and press it until the card tray ejects, and then remove the card tray.

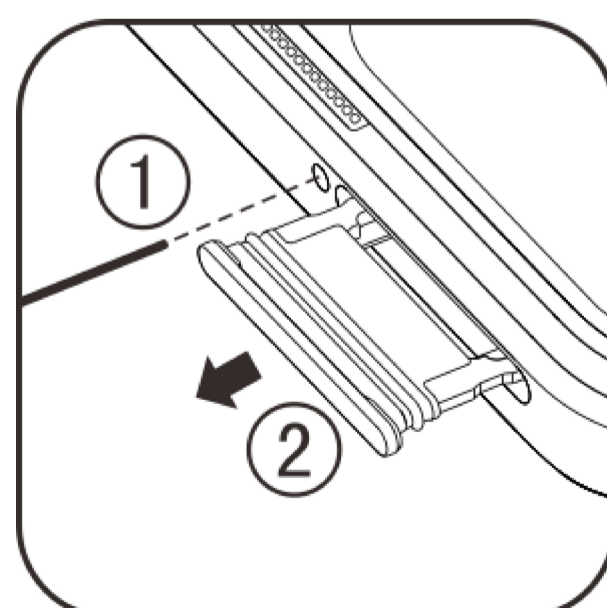

2. Follow the arrow direction shown in the diagram and fit the angled corner of your SIM card into the angled corner of the tray.



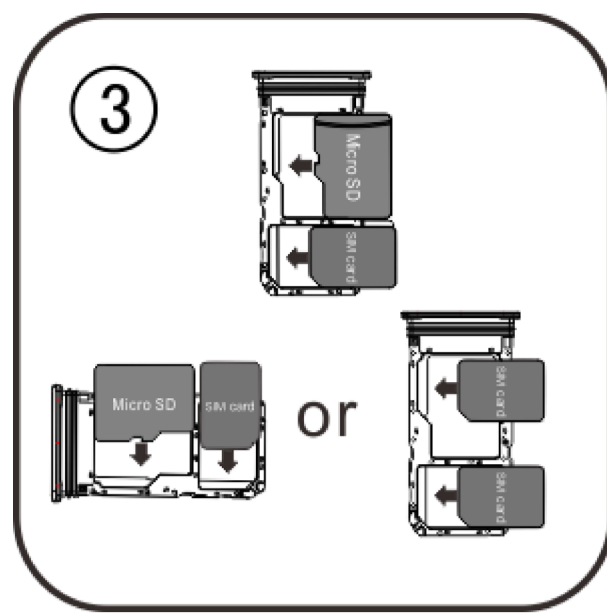

3. With the touch screen facing up, follow the direction of the arrow to install the tray (with Nano card) into the phone.

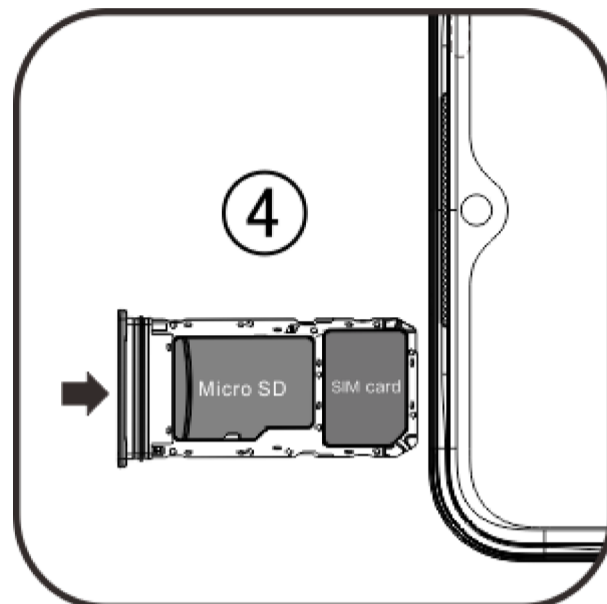

Note:

1. The back cover is not removable, so as not to damage the machine.
2. Put SIM card into card tray, then mount card tray into the phone. It is forbidden to insert the SIM card into the phone directly.
3. You are advised not to cut your SIM card by yourself. If the Nano card (SIM1/SIM2) does not match, please go to the carrier to change to a standard Nano card.
4. This phone supports "Dual SIM Dual Standby Single Pass", which means that voice or data services cannot be used on both cards at the same time. When a call is established on one SIM card, the other one cannot make or receive calls. Callers to the other card may hear the message "The number you have dialed is not in service" or "The number you have dialed is temporarily unavailable. Try again later". When one SIM card is using a data connection, the other one cannot use data services. The above situation is due to the Dual SIM Dual Standby Single Pass feature on this phone, and not related to the carrier's network. This phone supports only Single Pass because it has adopted the single-chip design, which can significantly increase standby time and reduce power consumption. You are advised to consult your local carrier to enable services such as "Missed call reminder", "Incoming call reminder," and "Secretarial service" to receive reminders for missed calls.

Connect headphones

Plug the headphone plug into the headphone jack on the phone, ensuring that the headphone plug is fully inserted.

Charge phone

Insert one end of the data cable into the USB port on the phone and the other end into the charger or a compatible device. The phone will start to charge. After charging is complete, disconnect the phone from the charger or the compatible device and remove the charger from the socket.

It is recommended to charge the device for at least 30 minutes before turning it on for the first time.

Note

Please use the data cable and charger that came with your phone.

Antenna

This phone is equipped with a built-in antenna. Please do not touch the antenna when it is transmitting or receiving signals. Touching the antenna may affect communication quality, cause the phone to operate using a power level higher than needed as well as shorten the battery life. The antenna is located inside the circle marked with dotted lines. Please do not cover this area when holding the phone, as shown in the picture below:

A. GPS antenna/ Wi-Fi antenna; B/C/D. Communication antenna.



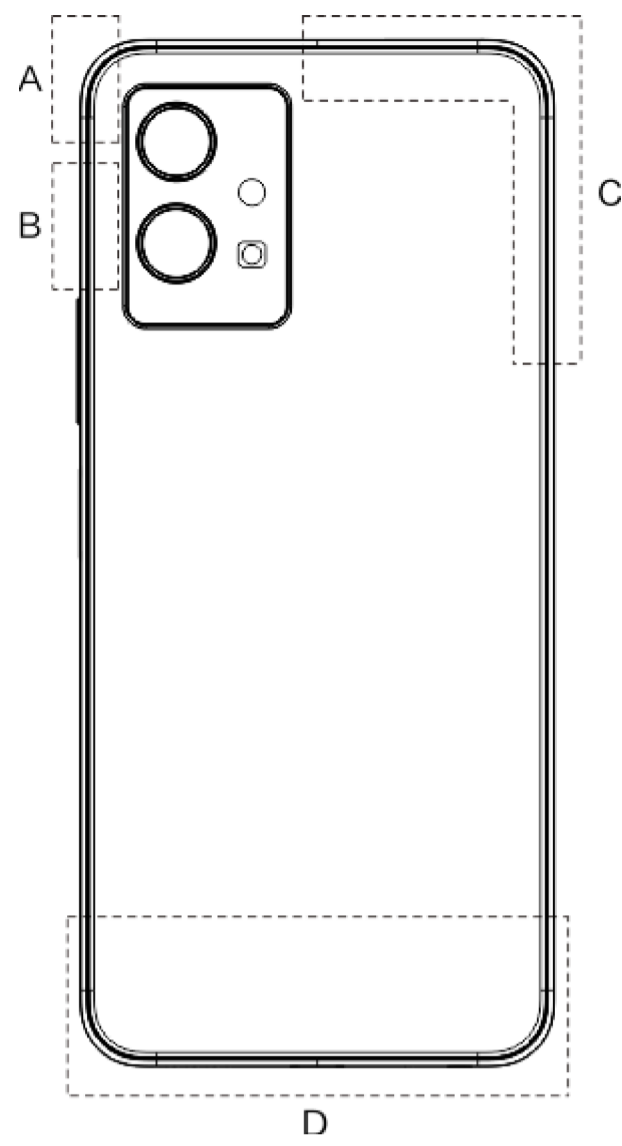

Note

The pictures used in these instructions are for reference only and may differ from your phone. Please refer to your phone.

Status bar icons and notifications

Meaning of status icons

The status bar at the top of the screen provides some basic status information of the phone, including signal strength, system time and battery power.

	Signal strength
	SIM card has no signal
	Airplane mode turned on
	Connected to Wi-Fi
2G/G/E	2G Network type icon*
3G/H/H+	3G Network type icon*
4G	4G Network type icon*
5G	5G Network type icon*
	Connect to Bluetooth device
	Vibration mode enabled
	Silent mode enabled
	Do not disturb mode enabled
	You have a new message
	Alarm on
	Battery power
	Charging
	Data Saver is on
	Hotspot is on



	Location is on
	VPN is connected

Note:

Network symbol is displayed to indicate current operators and network settings. The 5G icon is for illustrative purposes only and can only be shown on 5G network supported mobile phones.

View notifications

When you receive a new event notification, its content will be displayed on the status bar. You can slide down the status bar and tap the notification to view details.

About the home screen

When no app is open on your phone, your home screen will be displayed. This device supports multiple home screens. Swipe left or right to switch between these home screens. Swipe up on the home screen to view all the apps on your phone.

Change home screen settings

Tap and hold a blank area of the home screen to change your home screen settings, add widgets, or choose a wallpaper.

Search on the home screen

Tap the Google search bar and enter what you want to search.

Add apps to the home screen

In the app drawer, tap an app and drag it to wherever you want.

Control center

Swipe down from the top of the screen to open Control center, where you can tap an icon to quickly enable or disable the feature corresponding to that icon.

Home screen apps

iManager

iManager can effectively clear junk files from your phone, secure your phone, and provide various management tools to make your phone easier to use.

Phone management



Optimize: Check your phone's status, optimize your phone with one tap, and view recommended optimizations to improve your phone's performance.

Space cleanup: Scan and clean the cache with one tap. This feature also provides personalized recommendations of items to clean up based on your phone usage and has multiple special cleaning tools, making it easier to clean up the phone storage space.

Security scan: Detect system vulnerabilities, viruses, Trojan horses, malware, risky networks, and other security risks with one tap, so that you can deal with them in time. iManager also performs app security scans in the background to protect your phone in real time.

Data monitor: View your overall and app-specific mobile data or Wi-Fi usage. Tap an app to allow or not allow it to use mobile data in the background.

Note:

The carrier may adopt a data traffic calculation method which is different from that adopted by your device.

Apps & notifications: Configure app notifications and permissions.

More settings: On the iManager home page, tap  to go to the **Settings** page, where you can adjust the detailed settings of iManager and view more information.

Utility tools

More utility tools (such as privacy and security tools) are available to provide you with a better user experience.

Camera

Use Camera to capture photos and videos of wonderful moments in your life anywhere and anytime.

Open Camera

To open Camera:

- Tap the Camera icon on the home screen.
- On the lock screen, tap and hold the camera icon, and then swipe up.

Take a photo

To take a photo:

- Open Camera and tap the shutter button.
- Open Camera, choose Photo mode, and press a volume button.

Take multiple photos in quick succession

Open Camera, choose Photo mode, and tap and hold the shutter button. The number of photos captured will be displayed on the screen. Release the shutter button to stop shooting.

Record a video

To record a video:

- Open Camera and tap the video button. Tap the video button again to stop recording and save the video.
- Open Camera, choose Video mode, and press a volume button. Press the volume button again to stop recording and save the video.



View a captured photo or video

Tap the image in the lower left corner to view the captured photo or video.

Switch between the front and rear cameras

To switch between the front and rear cameras, tap the switch icon next to the shutter button.

Change the camera mode

Open Camera, swipe left or right on the screen, or tap to choose the mode you want.

Accessibility features

Open Camera, and turn accessibility features on or off at the top of the screen.

Flash: Tap the flash icon to adjust the flash mode.

HDR: When taking photos in environments with a strong backlight or a large contrast between bright and dark areas, turn on HDR mode to improve shadows and highlight details.



Note:

Some features may vary depending on the device model. Please refer to your phone.





Albums

View the photos and videos you have captured and various images stored on your storage device.

Slideshow

1. In **Photos**, open a photo or video, and tap  > **Slideshow**.
2. In **Albums**, open a photo or video in a folder, and tap  > **Slideshow**.

Share or delete photos or videos

1. In **Photos**, tap  or tap and hold a photo or video to enter edit mode, check one or more photos or videos, and tap .
2. In **Albums**, open a folder, tap  or tap and hold a photo or video to enter edit mode, check one or more photos or videos, and tap .

Recover or permanently delete a deleted photo or video

Open Albums, tap **Recently deleted**, and do the following:

1. Tap and hold to choose the photo or video, and then tap  to recover or permanently delete it.
2. Open the photo or video, and then choose to recover or permanently delete it.

Note:

To use this feature, you need to turn on **Recently deleted** on your phone. Deleted photos and videos will then be temporarily stored in **Recently deleted** and permanently deleted after a certain period of time.

Edit images



In **Photos** or **Albums**, open an image, and tap  to edit the image.

Calculator

Calculator can be used in multiple modes to perform basic and advanced calculations.



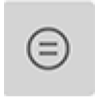

Open Calculator

To access Calculator:

- Swipe up on the home screen. You will see all the apps on your phone. Enter **Calculator** in the search box to quickly locate and open Calculator.
- Swipe down from the top of the screen to open Control center, and tap  in Control center to open Calculator.

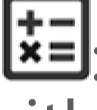
Change the calculator

In the Calculator app, you can change the calculator as needed.

- : Your phone uses the basic calculator by default, which can be used to perform simple arithmetic calculations.
- Tap  to switch to the scientific calculator, which involves advanced operators and functions.
- Tap  to switch to the currency conversion calculator, which can be used to convert exchange rates.
- Tap  to view the calculation history of the basic or scientific calculator.

Note:

You must connect your phone to the internet to use the currency conversion calculator.







Recorder

Use the Recorder app to record voice memos in your work and life. It uses the built-in microphone on your phone to record. In the **Recorder** app, you can perform the following actions:

Tap  to start recording. Tap  to pause recording. Tap  to stop and save the recording.  marks a time point.



Play a recording

To play a recording:



1. Choose the recording file and tap  to play or pause it. Drag the slider on the progress bar to go forwards or backwards.
2. Open the recording file to play it. To pause playback, tap . To continue playback, tap .  marks the time point. To change the speed, tap . To turn Speaker mode on or off, tap . Tap a mark during playback to quickly jump to the marked location in the recording.







Share and delete a recording

Tap and hold the recording file you want to share or delete, or tap  > **Select**, check the recording file, and then tap / .

Set a recording as a ringtone

Tap and hold the recording file you want to set as a ringtone, or tap  > **Select**, check the recording file, and then tap  > **Set as ringtone**.







Trim a recording

Open the recording file you want to edit, tap  > **Trim**, drag the timeline slider, and tap /  to preview or continue the recording. Trim a part of the recording, tap  to save or delete the selected part, and then tap .



Clock

The Clock app has four features: Alarm, Clock, Timer, and Stopwatch.

Alarm





1. To add an alarm, tap . To edit an alarm, tap the alarm to enter the alarm settings page. Tap /  to switch to the analog clock or digital clock, set up a recurring alarm, set the alarm sound, and tap  to save the alarm.
2. To delete one or more alarms, open Clock, tap  > **Select**, check the alarms, and tap . You can also tap and hold to choose the alarms and then tap  to delete them.

Clock



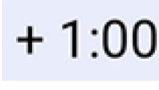

1. Tap  to add the time in cities worldwide.
2. Convert time zones: If you have added two or more cities, tap  > **Time converter**, and select a city, date, and time.

Timer

You can use the timer to count down from a specified time. Set the duration of time and tap  to start a timer.

During the countdown, you can tap + to add and start more timers, tap  to delete the timer, tap  to extend the timer for 1 minute, tap  to pause the timer and tap  to continue the timer, or tap **Reset** to reset the timer.

Stopwatch

Tap  to start a stopwatch. Tap  to record a lap time. Tap  to pause the stopwatch. Tap  to reset the stopwatch. Tap  to share or copy the lap times.



Compass

You can check out directions, longitude, latitude, and the horizontal line with the compass. Before using the function, please make sure your phone is in landscape mode and away from electromagnetic interference, to ensure accuracy.

Note:

1. Please turn on network connection and location service before checking your current location.
2. When under severe interference, the compass will be switched to the calibration window; the compass will resume working after calibration.
3. The digital compass can only be used to assist navigation. Please do not use it to determine an accurate location, proximity, distance or directions.

vivo.com

You can learn more about vivo and our products on the **Home/Products** page, and provide feedback as well as find solutions to frequently asked questions on the **Support** page.

Note:

You must connect your phone to the internet to use this feature.

Themes

Download and purchase

The recommendations and categories include various themes, fonts, and wallpapers. You can try them out or purchase them based on your preferences.

Change a theme

The following steps describe how to change a theme. The process of downloading a wallpaper, lock screen, font, or other resources is similar.

1. Tap **Me > Local themes/Purchased**, select a theme, and tap **Apply**.
2. To use a paid theme, pay for the theme and download and apply it. To use a free theme, download and apply it.

Your lock screen wallpaper, home screen wallpaper, and home screen icon styles will be changed based on the theme by default. To set the wallpapers not to change with the theme, tap **Local >**  and turn off **Change home screen wallpaper based on theme** and **Change lock screen wallpaper based on theme**.

Note:

You must connect your phone to the internet to download resources online.



Music

You do not need to add songs manually. Your phone will scan for songs on the storage device automatically when turned on and add them to **Music**.

Lists

Open Music from the home screen and tap **Lists**. Tap **New playlist** to create a playlist of your favorite songs.

1. Add a song to your custom playlist:

Go to the **Songs** list, tap and hold the song you want to add, and tap **Add to playlist** in the pop-up window.

2. Edit a custom playlist: Open the playlist, tap , mark one or more songs, and then tap **Add to playlist/Remove**.

3. Delete a custom playlist: Tap and hold the playlist, and tap  in the pop-up window. Deleting a custom playlist will not delete the songs in it.

Search

When there are many songs, you can tap  and enter the name of a song, an artist, or an album to quickly find what you want.

Settings

Go to the  page to configure the settings for Music.

Scan for songs: Tap **One-tap scan** to scan for songs on your phone. You can filter folders or songs to not display them in the Songs list.

Sleep mode: Drag the slider in the middle to set the amount of time you want your music to play for, and turn on **On**. When **Sleep mode** is turned on, your phone will automatically stop playing music after the set amount of time is up. You can choose either to only stop playing music or to stop playing music and turn off your phone after the set amount of time is up.

Audio effect: Tap **Audio effect** to set your preferred sound effects.

Weather

Add cities

Tap  to go to the **City management** page, and tap  in the upper right corner to add more cities.

Check the weather

On the Weather home page, swipe left or right on the weather curve to see the temperature changes and weather conditions for the next 22 hours. To view another city, swipe left or right on the screen.

Rearrange the order of cities

Tap  to go to the **City management** page, tap , tap and hold , and move the city up or down to reorder it.



Delete a city

On the **City management** page, tap and hold the city you want to delete, and tap **Delete**.

Weather settings

Tap  to set your preferred weather display.

Note:



You must connect your phone to the internet to use this feature.

EasyShare

Use EasyShare to send or receive files without using mobile data.





Data-free, superfast file transfer

You can simultaneously transfer files of various types at a high speed without using data. For example, if you use EasyShare on an Android-powered device (source phone) to send files:

Tap , select the files to transfer, and tap **Send**. On the phone to which the files are to be transferred (target phone), tap  to search for the source phone or scan the QR code on the source phone to connect the phones. Then tap OK on the source phone.

Phone Clone

Phone Clone is secure and efficient and requires no data usage to quickly import data, including contacts, messages, and photos, from your old phone to your new phone.

On your old phone, tap  > . On your new phone, tap  > , select the operating system on your old phone, and scan the QR code on the old phone or manually connect to the old phone's hotspot.

Data backup

Download and install EasyShare on your PC, connect your phone to the PC via a USB cable, and then back up or restore data. You can also tap **Wi-Fi connection** on your phone, scan the QR code on the PC, and then back up or restore data.

Share EasyShare

To share EasyShare:

1. Scan the QR code to go to the official website and download and install EasyShare.
2. Share via Bluetooth or Wi-Fi.
3. Share via WhatsApp or SMS.





Notes

Create notes as you like to jot down your ideas and inspirations.











Create a new note

1. To create a new note:

- Tap  on the  page.
- Open a folder on the  page, and then tap .

2. You can perform the following actions in a note:

- Tap  to set the text formatting such as the font size.
- Tap  to create a to-do list. After you create the list, tap  to mark a task as completed.
- Tap  to set a reminder for the note.
- Tap  to add a photo to the note.
- Tap  to turn on recording mode.
- Tap  to change the note's background or add a table to the note.
- Tap  to undo or redo edits.

3. Tap  to save the note.

Mark a note

Open the note you want to mark, and tap .

Pin or hide a note



Tap and hold the note in the Notes list, and then tap **Pin/Encryption** in the pop-up window.

Share or save a note

Open the note you want to share or save, and tap .

Delete notes

To delete one or more notes:

1. Tap and hold the note you want to delete, and tap **Remove** in the pop-up window.
2. In the Notes list, tap , select one or more notes, and then tap .
3. Open the note you want to delete, and tap .

Browser

vivo Browser is based on a new optimized kernel and provides you with a smooth browsing experience with powerful website navigation and an interactive UI design, which is similar to that of PC browsers.



Open **Browser** from the home screen. Tap  on the Browser home page. A shortcut menu will be displayed, where you can configure the browser as needed.

Search for content

Enter what you want to search for in the top search bar and tap **Search**. The search results will be displayed.



Open a new tab

In the lower right corner of the screen, tap  >  to open a new window.

View browsing history and bookmarks

In the bottom navigation bar, tap  >  to view all your browsing history and saved bookmarks.

Google apps

Google provides entertainment, social networking and other apps. Some apps may require you to sign in to your Google account for further access. For more information on apps, use their help pages.

About some features

Chrome/Google: You can search and visit webpages through Google Chrome.

Gmail: You can send and receive emails through Google Mail services.

Maps: Google Maps helps find your location and nearby facilities. You can also fill in your commute information to get traffic information in advance.

YT Music: YouTube Music has the coolest new music and videos for you. Stream or save music to your device.

YouTube: You can enjoy the videos shared by others or upload your own on YouTube.

Photos: Google Photos is the perfect place to edit and manage your photos and videos from all sources.

Assistant: Google Assistant can help you send SMS messages, make phone calls, and plan routes all with your voice.

Duo: Google Duo helps you keep in touch with friends and family through videos calls.

Files: Files helps you manage, share and clean up your saved files and apps.

Google pay: Google Pay puts together all payment methods supported by Google so you can enjoy quick and secure payments after entering your bank information once.

Calendar: After you set reminders, Calendar can remind you of upcoming events by sending you a notification.

Play Store: After logging in, you can find the latest Android apps, games, movies, music and other amazing content. You can search for and download any content according to your personal needs.

Phone: Use Phone to make calls.

Contacts: Contacts is where you can save and manage your contacts.

Messages: You can use Messages to send and receive SMS messages, photos, videos, audios or other files.

Note:



App availability and functions may vary depending on your region and service provider.



Settings

Network & internet

●Wi-Fi

Turn on or off Wi-Fi in **Wi-Fi**. When Wi-Fi is on, choose the Wi-Fi network that you want to connect to.  indicates an encrypted network, which requires a Wi-Fi password. When your phone is connected to a Wi-Fi network, the Wi-Fi signal strength will be displayed as  in the status bar. The more bars, the stronger the signal. If there is no available Wi-Fi network or if Wi-Fi is off, your phone will connect to the data network for internet access. Once your phone is connected to a Wi-Fi network, it will connect to the network automatically when in range.

To add a Wi-Fi network that is not on the list of available networks, tap  and enter the network SSID. To connect to a hidden network, you must know the network name, password, and security type.

●SIM card & mobile network

From here, you can view the current SIM card status and adjust the SIM card settings according to your usage.

Mobile data: Turn on this option to use apps such as Browser and Mails over the data network. Carrier charges may apply. For details, consult your carrier.

Preferred SIM for: If you are using two SIM cards, set the preferred SIM card for mobile data and calls. Your phone will automatically use the preferred SIM card.

SIM card info and settings: Choose a SIM card to view or set the SIM card information (such as the SIM card name), primary network type, and data usage of each app on the SIM card.

●Hotspot & tethering

Share your Wi-Fi, Bluetooth, or USB network hotspot with other devices to allow them to access the internet via your Wi-Fi or data network.

To turn on a hotspot:

- Swipe down from the top of the screen to open Control center, and tap .
- Go to **Settings > Network & internet > Hotspot & tethering > Wi-Fi hotspot**, and turn on the switch.

Manually set the hotspot name, usage security, and single-use data limit as needed.

●Data Saver

Data Saver prevents some apps from using data in the background and thereby helps reduce data usage. In **Not restricted by data limit**, turn on or off the switch for each app based on your data-saving needs.

●Network management



This list includes all apps allowed to access the data network or Wi-Fi. You can enable or disable the internet permission for these apps as needed.

●Airplane mode

You must turn on Airplane mode on your phone while flying in an airplane.

To turn on Airplane mode:

- Swipe down from the top of the screen to open the Shortcut Center, and tap .
- Go to **Settings > Network & internet**, and turn on **Airplane mode**.

●VPN

Your company's VPN allows you to securely communicate private information over a non-dedicated network. For example, you can use the VPN to access your business emails.

Tap **VPN > +**, enter the VPN information got from the administrator, configure the VPN file, and save the settings. You can then enter your username and password to use the VPN.

●Private DNS

A private DNS can protect your privacy and security while connecting to a target URL.

To turn on/off or change the private DNS settings, tap **Private DNS** and follow the on-screen instructions.

Bluetooth & devices

●Bluetooth

With Bluetooth, you can connect to other Bluetooth devices such as earphones, car kits, speakers, phones, keyboards, and mice. It also allows you to transfer files, including documents, contacts, images, music, and videos, between two mobile devices (such as phones and tablets).

●Smart Mirroring

1. **Local file mirroring:** Play videos, images, and music from your phone on a connected device.
2. **Phone screen mirroring:** Display content of your phone screen on a connected device synchronously. You can directly tap the content on your phone to proceed.

●OTG

On-The-Go (OTG) is a technology that allows storage devices to transfer data without requiring a host. For example, with a USB OTG cable, you can connect your digital camera to a printer and directly print photos from the camera. Use an OTG cable to connect a storage device to your phone and turn on **OTG**. You can then open File Manager to manage the images, videos, and music files on the storage device.

●Printing

You can use some apps on your phone to print. Before printing, add a printer that can get data over the internet.

●Chromebook



Connect your phone to a Chromebook to unlock the Chromebook with your phone or send and receive messages on the Chromebook.

●Nearby Share

To use this feature, you need to turn on Bluetooth and enable location services and register or sign in to a Google account. Nearby Share allows you to share or receive content from nearby contacts.

●Android Auto

To use this feature, you need to register or sign in to a Google account and have downloaded and installed the **Android Auto** app. Android Auto allows you to use Google Assistant to control the map, media, and messages while driving.

Display & brightness

Adjust the system settings such as the screen brightness and auto-lock time.

Adjust the screen brightness

To adjust the screen brightness:

- Swipe down from the top of the screen to open Control center, and drag the slider (●) to adjust the screen brightness manually or tap **A** to enable auto-brightness.
- Go to **Settings > Display & brightness**, and drag the slider to adjust the screen brightness manually or enable **Auto-brightness** to make your phone automatically adjust the screen brightness based on the ambient light conditions.
- **Eye Protection** automatically adjusts the screen color temperature to make the screen light warmer and softer, which can help reduce eye strain. You can turn it on immediately or at a set time as needed.
- **Dark theme** uses a solid black background, which can help reduce screen glare and extend battery life. You can turn it on immediately or at a set time as needed.

Auto-lock screen settings

In **Screen timeout**, select a preferred duration. The screen will lock automatically after it has been idle for the selected duration.

Screen rotation settings

Auto-rotate allows the screen to rotate automatically when you rotate your phone between portrait and landscape modes.

Screen color mode/color temperature settings

In **Screen colors**, manually adjust the screen color mode (or color temperature) based on your usage habits.

Font settings

Font size: Different font sizes are available for you to choose as needed.

Font style: Check the currently used font or download and use other fonts.

Status bar settings



In **Status bar**, turn on or off display options related to the status bar (such as the network speed display or battery percentage).

Screen saver settings

In **Screen saver**, set a screen saver to show up when your phone is charging or docked.

App aspect ratio settings

Full screen display of apps: Apps that do not automatically display in full screen are listed here. To display an app in full screen mode, turn on the switch for the app.

Display at the top of the screen: Apps that display/do not display at the top of the screen are listed here. Tap an app to learn about the display features and select a display mode as needed.

Lock screen & wallpaper

Themes and wallpapers

You can download or use your preferred themes or wallpapers. You can also use an image in Albums as a wallpaper.

Other settings

Lock screen settings: Download or use your preferred lock screen wallpaper, and turn on or off **Change lock screen wallpaper based on theme**. Tap **Add text on lock screen** to add text and symbols to display on the lock screen.

Home settings: Specify whether to add icons for new apps to the home screen, whether to rotate the home screen when the phone is rotated, whether to show the app suggestions bar, and whether swiping down on the home screen opens Global Search or Notification center.

Note:

You must connect your phone to the internet to browse or download new styles.

Simple Mode

Turn on Simple Mode to use the home screen with a simple layout and a larger font size.

Dynamic effects

A variety of animation styles are provided under the corresponding feature. You can select and apply your favorite style.

Sound

Set your preferred sound profile in **Settings > Sound**.



Volume button adjustment

Use the volume buttons to adjust the media or ringtone volume as needed.

Phone vibration settings

In **Vibrate for calls/Notification vibration**, set the vibration mode or strength based on your usage habits.

Do Not Disturb

In **Do Not Disturb** mode, your phone will only receive notifications from important contacts and apps. You can specify which contacts or apps to allow notifications from as needed.

To turn on Do Not Disturb:

- Swipe down from the top of the screen to open Control center, and tap .
- Go to **Settings > Sound > Do Not Disturb**, and tap **Turn on now**.

Custom ringtones

For example, to **Alarm ringtone**, pick a ringtone from the provided options or use an audio file on your phone as a custom ringtone. You can set other message or notification ringtones in a similar manner.

Other sound and vibration settings

Sounds: Sounds can also be set for touches, charging, and other occasions. Turn on or off the sounds based on your usage habits.

Touch vibration: Adjust the touch vibration frequency or enable haptic feedback.

Apply

This list includes all apps and services installed on this device. You can set detailed permissions for apps and notifications based on your usage habits.

View or edit app information

All apps and recently used apps are listed here. Tap an app to view its build number, used storage space, and usage duration, and adjust its permission settings as needed.

Screen time

Tap  to check how much time you spend on each app, how many notifications you have received, and how often you unlock/open an app on the current day.

Set app timers: Tap  to set a daily timer for an app. When the app timer ends, the app will be paused for the rest of the day.

Default apps

When you have multiple apps that can be used for the same task, you can choose the app to use by default.



Battery

Check the current battery usage and more, and switch to Battery Saver or Balanced mode as needed.

Background power consumption management

In **Background power consumption management**, check the power consumption of each background app on the current day, and allow or don't allow certain apps to continue running in the background as needed.

Note:

The power consumption is approximate and may vary depending on usage.

RAM & storage space

Go to **RAM & storage space** interface, you can check the memory usage of the storage devices, as well as format the storage devices. All data will be cleared after the phone storage has been formatted. Please make sure that you have backed up important data before formatting.

Security

Update your security status or configure security features to keep your phone secure.

Security status

Check your app security scan/update status. **Find My Device** can help you remotely locate your device and keep your phone data secure when your device is lost.

Device security

Set a screen lock or enroll your fingerprint (or face) to improve your phone's security.

1. **Lock screen password:** Tap **Screen lock** and set a lock screen password (such as a pattern or a numeric password) as needed.
2. **Fingerprint unlock:** Set a secondary screen unlock method. After setting a lock screen password and enrolling your fingerprint, turn on **Unlock**. You can then use the enrolled fingerprint, draw the unlock pattern, or enter your numeric password to unlock the phone.
3. **Face unlock:** Set a secondary screen unlock method. After setting a lock screen password and enrolling your facial data, turn on **Unlock**. You can then unlock the phone with your face when the screen is on and locked.
4. **Smart Lock:** After setting a lock screen password, use Smart Lock to keep your phone unlocked in certain circumstances (for example, when your phone is on you or in certain locations). Each option is described in detail.
5. **Privacy & app encryption:** A privacy password is used to encrypt apps, messages, and notes. Follow the on-screen instructions to set your privacy password and security questions.
 - Use the privacy password to encrypt apps: Turn on the switch for the apps you want to encrypt, then lock the screen or exit the apps. You can also specify from when the app lock takes effect as needed.



· Use the privacy password to hide apps: Turn on the switch for the apps you want to hide. The apps will then be completely closed, which means they will no longer be displayed on the home screen or in the list of recent apps or other app lists, nor will they receive new messages. You can also specify how and from when the apps are hidden (for example, when you lock the screen or exit the apps) as needed.

Privacy

Here is a collection of functional settings for the security of the phone, such as system security and privacy. Adjust the settings as needed.

Description of some features

Permission manager: Check the apps that are currently allowed/denied access to permissions such as Storage, Location, and Calendar, and adjust the app permissions as needed.

Show passwords: When enabled, the characters of a password will be displayed briefly during input.

Notifications on lock screen: Configure how notifications are displayed on the lock screen.

Recent apps preview: After "Blur recent apps" is on, you can turn on or off blur preview for specified apps as needed.

Screen capture protection: When enabled, third-party apps will be prohibited from taking screenshots or recording the screen during password input so as to prevent password disclosure.

Unlock to turn off the locked phone: When this feature is enabled, you must unlock a locked device before turning off or restarting it.

Note

This feature will only appear when a lock screen password is set for your phone.

Location

You can set for the location function under **Settings > Location**. After opening the function, apps such as Maps and Camera as well as third-party location-based apps can collect and use location data. When you do not need location data, you can disable the function to save battery power.

Note:

The location service will use the larger network traffic that is recommended for you to use the Wi-Fi network.

Ultra Game Mode

Your phone will automatically add downloaded games to Ultra Game Mode. You can also manually add games to Ultra Game Mode to let the games use Ultra Game Mode features. Tap the Add button and select games.



Choose a game mode

Esports Mode: Each feature is described in detail. Go to **Supported games** to check which installed games support Esports Mode, which provides pro players with a more immersive and smoother gaming experience. To turn on Esports Mode, bring up the sidebar in a supported game.

Autoplay with screen off: To turn on this mode, bring up the sidebar in a game added to Ultra Game Mode. In Off-screen Autoplay mode, games will continue running when the screen is off or locked. This helps reduce power consumption while running games in the background.

Experience enhancement/Do Not Disturb settings

Features such as sound effects and visual effects are available to enhance your gaming experience. Go to the features and follow the on-screen instructions to learn more about and enable the features as needed.

Shortcuts & accessibility

●S-capture

Use S-capture to take screenshots, record the screen, or record animated GIFs.

To take a screenshot:

- Swipe down from the top of the screen to open Control center, tap , and select an appropriate screenshot method.
- Swipe down with three fingers to take a quick screenshot.
- Press and hold the power button and volume down button simultaneously to take a quick screenshot.

Turn on **Screenshot floating window**. A floating window will be displayed when you capture a screenshot. You can tap the floating window to preview, edit, and share the screenshot.

●Smart Split

Smart Split allows you to handle two apps easily at the same time. In some apps, an incoming message will be displayed as a floating icon. Tapping the icon will split the screen into two halves, giving space to both apps.

Enable screen-split: For details on how to enable screen-split in different circumstances, refer to the on-screen text and animated instructions.

Recommended screen-split apps: When enabled, the system can intelligently predict which app you want to open on a split screen and recommend it to you as the first choice.

●Smart Motion

Here is a collection of various Smart Motion features. Go to the features and follow the on-screen text or animated instructions to learn about and enable the features as needed.

●Quick action

Turn on **Quick action** and select a feature or app (such as Flashlight or Camera). You can then press and hold the volume down button to quickly start the selected feature or app when the screen is off.

Note:

Quick action cannot be used during music playback or if the IR sensor is blocked.



●Easy Touch

Easy Touch provides easy access to some commonly used apps or shortcuts on your phone. When enabled, Easy Touch will be displayed on the screen as a floating button (like .

Description of some features:

- **Customize features:** Go to **Customize menu** and tap  to add other shortcuts or commonly used apps to Easy Touch.
- **Change skins:** Easy Touch is available in multiple skins. Go to **Personalized skins** and choose your preferred skin.
- **Set display effects:** In **Display effects**, set the idle visibility of Easy Touch, specify whether Easy Touch automatically moves to a screen edge after 3 seconds of inactivity, and choose whether to automatically hide Easy Touch in full screen mode.

●Flashlight reminder

If you turn on the switch for an event, the rear flash will blink when the event occurs with the screen off. Enable this feature for events as needed.

●Task timer

After you set **Scheduled power on/off**, your phone will turn on or off automatically as scheduled. Before turning off, the phone will ask you to confirm whether you want to turn it off. If not, tap **Cancel**. If you do not confirm or cancel the power off, your phone will turn off after 60 seconds.

You can set **Scheduled vibration mode/Scheduled airplane mode** in a similar manner.

●One-handed

When **Access mini screen using gesture** is enabled, you can swipe in from the edge of the screen and then swipe out to open a mini floating window.

Tap and hold the title bar of the mini floating window to drag it to your preferred position on the screen. Tap  and zoom with two fingers or drag the edit icon to adjust the mini screen size.

●Accessibility

Accessibility features let you better interact with your phone apps. They make apps more functional and your phone easier to use. Turn on/off and set accessibility features to suit your needs.

Description of some features:

- **Downloaded apps:** View downloaded features that can read the content of the screen or use buttons to control the phone. For details on how to use a feature, refer to the relevant text description.
- **Screen readers:** Enable this feature to hear the on-screen text. You can select your desired engine, language, speed, and tone.
- **Display:** Configure display settings (such as the font size and zoom). For details on how to use a feature, refer to the relevant text description.
- **Interaction controls:** Configure options related to interaction with the phone (such as the response time to screen taps or presses).
- **Audio & on-screen text:** Set your preferred sound channel and subtitles for playing audio.

Digital Wellbeing & parental controls

You can check the usage of the device here and adjust the settings of some functions to reduce the interference the device causes to you. You can also set up Parental Control to control and manage the use of the phone by your child.



Google

You can adjust some of the functional configurations provided by Google here. Tap  on the home screen to learn about detailed solutions to related problems.

Accounts

Add account

To add an account, tap **Add account** and select the account type. You can add multiple types of accounts.

You must register and sign in to a dedicated Google account to use some features on the phone.

Automatically sync app data

Turn on **Automatically sync app data** to automatically sync app data.

Note:

You must connect your phone to the internet to use this feature. The auto-sync feature uses power and data. You are recommended to turn it off once you have finished syncing.

System

●System navigation

Gesture navigation: Use gestures to quickly go back to the previous screen, go to the home screen, and switch between apps.

3-button navigation: Tap buttons to quickly go back to the previous screen, go to the home screen, and switch between apps. You can change the order and styles of the buttons as you like.

●Languages & input

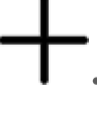
To add a language, tap **Languages** > . To set an added language as the default, drag the language to the top of the list.

To manage supported input methods, tap **On-screen keyboard** >  and turn on or off input methods as needed.

●Date & time

The phone can get the correct time over the internet. You can manually adjust the time zone and time and turn on or off the 24-hour format as needed.

●Back data / Restore data



You can back up apps and data on your phone on the Google server (or vivoCloud), and restore backed up information to your phone.

●Reset options

Reset your phone's network/Bluetooth settings and restore or erase all data as needed.

⚠Note:

Using **Erase all data** will delete all data from your phone's internal storage.

●Phone Clone

Phone Clone clones data from an old phone to a new phone with one tap without using data.

For example, on your new vivo phone, tap  and select the type of your old phone (iPhone or Android phone). Then open the app on the old phone and scan the QR code as prompted.

About phone

Go to **About phone**, You can learn a variety of information related to the phone. For legal information, go to **About phone > Legal information**.

Customer service: You can find the phone manual, E-warranty card and other information here to make better use of your phone.

⚠Note:

Before using this function, please enable network access on your phone.

Developer options

Developer options is used by Android developers. Enabling set options under **Developer options** may cause your apps or device to crash or act abnormally. Please use it with caution. Before using the PC tool to manage the device, please enable **USB debugging**. The **USB debugging** switch is under the **Developer options** menu. Steps to call up the **Developer options** menu:

1. Enter **Settings > About phone > Software information**.
2. Tap seven times on **Build number**.
3. The **Developer options** menu will appear in **Settings > System**.

System update

You can use **System update** to easily and quickly upgrade your phone system. First, enable the Wi-Fi or data network. Then go to **Settings** and tap **System update**. The phone will automatically detect new software version, which you can simply download and install.

⚠Note:



A recovery or system update that is not performed by the Company may cause security risks. It is recommended that you back up important data to a storage device before upgrading. System update may incur a high amount of data traffic. You are advised to use Wi-Fi.

App Clone

Go to **App Clone**, and switch on installed apps that support such a function. When the switch is on, a clone App will be generated on the screen.

Copy the application as "II·xxx", to distinguish the original application. This function allows you to sign in with another account. Switching accounts in one app is unnecessary.

Note:

1. Uninstalling or closing the original app will also delete the cloned app and its data.
2. Two apps may increase data usage. Please promptly clean up data usage with iManager.
3. In view of the actual use of scenes and third-party app restrictions, this feature only supports apps that require account sign-in. Other apps currently don't support this function.
4. App Clone can only be used on vivo's original home screen and may not work well on other types of home screens.

Multiple users

Description of user types

User: A person who doesn't own but may often use your device. Each user has their own exclusive space and can set their own home screen, sign in to accounts, and install apps.

Guest: A person who uses your device for a short time. Guests also have their own space on the phone, which can be easily deleted by you when no longer used.

Add or remove a new user

To add a new user, turn on **Multiple users** and tap . You can then switch to the user account and let the user set up their exclusive space on the phone.

Remove a user:

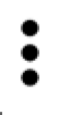
- If you are the owner of the phone, tap the username and then tap . All apps and data under this username will be deleted.
- If you are not the owner of the phone, tap  and then tap "Delete XXX (username)" in the pop-up window. User deletion cannot be undone. The phone will then switch back to the owner's space.

Notification

Conversations

Specify a way to receive SMS messages or message notifications from apps. Prioritized or edited chats are displayed here.



To edit a chat, swipe down from the top of the screen to open Shortcut center, and tap and hold the chat you want to edit.

Manage

Here you can view the notification history from certain apps or the entire phone, and you can also set whether to allow apps and devices to read notifications.

1. To edit a single notification, swipe down from the top of the screen to open Shortcut center, tap and hold the notification, and tap  to turn on or off the app notification and change the notification type as needed.
2. To clear a notification, swipe left or right on the notification or tap "Clear all" under all notifications.

Note:

Some notifications can only be cleared after relevant actions have been performed.

Regular

Here is a collection of notification-related settings, such as notification sound, notification delay, and display forms of home screen app icon badges. You can turn on/off or select corresponding options according to your preferences.

Wireless Emergency Alerts

After you turn on Wireless Emergency Alerts, you can manage the emergency alerts (such as threat alerts or AMBER alerts) you want to receive, set the alert frequency, and turn on or off vibration.

Device Maintenance

About maintenance

A thorough understanding of the maintenance and servicing of the phone may help you make safer and more effective use of your phone to extend its service life as far as possible. For more information, refer to the paper manual included with your device.

Phone and accessories

This phone uses the Android operating system. To view the phone's version, go to **Settings > About phone**.

In **Settings > About phone > Legal information > Safety information**, you can learn the safety considerations for this device to help you use it in a safer way.



Help

If you have any questions during your use of the phone, contact your network carrier or our after-sales service center. Go to **Settings > About phone > Customer service > Service center** to find our after-sales service hotline.

Supported file formats

Video recordings	MP4
Pictures	PNG, JPG, BMP, and GIF
Sound recordings	M4A
Music	MP3, OGG, WAV, MIDI, FLAC, M4A, AAC, AMR, AWB, and MP2
Video	AVI, MP4, and 3GP

Instructions for connecting to USB

Connect your phone to a PC using a USB cable, swipe down the notification bar on your phone, tap the charging connection notification, select **File transfer** on the redirected page, so that you can manage files on your phone using the PC.

Windows

1. In Windows 7 and later, users do not need to install any drivers. You can double click "Computer" (Windows 7) or "This Computer" (Windows 10) on the desktop to view your device, and then double-click it to copy and manage the files on your phone.
2. In Windows XP, users need to install the MTP driver. Go to www.vivo.com on your computer, select the "Support" tab, and type "USB" in the search box to find the link for the MTP driver. Download and install the driver to manage the files on your phone using your computer.



Note:

To use the function properly, computers running Windows XP need to install Windows Media Player 11 or above.

macOS

1. macOS users need to download "AndroidFileTransfer.dmg" to manage the phone files.
2. Visit vivo official website www.vivo.com, choose "Support", and click on "USB" to download the macOS MTP management tool. After the download is completed, you can open it to use the computer to manage the phone files.

Linux

Manage the phone files using mtpfs software:

1. Install tool "sudo apt-get install mtp-tools mtpfs";
2. Create new directory "sudo mkdir /media/mtp";
3. Modify the directory permission "sudo chmod 755 /media/mtp";
4. Install device "sudo mtpfs -o allow_other /media/mtp", then you can manage the phone files in the file manager;
5. Unload device "sudo umount /media/mtp".

During installation, do not disconnect the USB data cable between the phone and the computer. If it cannot be used after being installed, please restart the computer or reinstall.

